

GC 172 Wireless ceiling-mounted smoke detector

EN Supplementary sheet

183121_01



Germany
GEZE GmbH
Niederlassung Süd-West
Tel. +49 (0) 7152 203 594
E-Mail: leonberg.de@geze.com

GEZE GmbH
Niederlassung Süd-Ost
Tel. +49 (0) 7152 203 6440
E-Mail: muenchen.de@geze.com

GEZE GmbH
Niederlassung Ost
Tel. +49 (0) 7152 203 6840
E-Mail: berlin.de@geze.com

GEZE GmbH
Niederlassung Mitte/Luxemburg
Tel. +49 (0) 7152 203 6888
E-Mail: frankfurt.de@geze.com

GEZE GmbH
Niederlassung West
Tel. +49 (0) 7152 203 6770
E-Mail: duesseldorf.de@geze.com

GEZE GmbH
Niederlassung Nord
Tel. +49 (0) 7152 203 6600
E-Mail: hamburg.de@geze.com

GEZE Service GmbH
Tel. +49 (0) 1802 923392
E-Mail: service-info.de@geze.com

Austria
GEZE Austria
E-Mail: austria.at@geze.com
www.geze.at

Baltic States –
Lithuania / Latvia / Estonia
E-Mail: baltic-states@geze.com

Benelux
GEZE Benelux B.V.
E-Mail: benelux.nl@geze.com
www.geze.be
www.geze.nl

Bulgaria
GEZE Bulgaria - Trade
E-Mail: office-bulgaria@geze.com
www.geze.bg

GEZE GmbH
Reinhold-Vöster-Straße 21–29
71229 Leonberg
Germany

China
GEZE Industries (Tianjin) Co., Ltd.
E-Mail: chinasales@geze.com.cn
www.geze.com.cn

GEZE Industries (Tianjin) Co., Ltd.
Branch Office Shanghai
E-Mail: chinasales@geze.com.cn
www.geze.com.cn

GEZE Industries (Tianjin) Co., Ltd.
Branch Office Guangzhou
E-Mail: chinasales@geze.com.cn
www.geze.com.cn

GEZE Industries (Tianjin) Co., Ltd.
Branch Office Beijing
E-Mail: chinasales@geze.com.cn
www.geze.com.cn

France
GEZE France S.A.R.L.
E-Mail: france.fr@geze.com
www.geze.fr

Hungary
GEZE Hungary Kft.
E-Mail: office-hungary@geze.com
www.geze.hu

Iberia
GEZE Iberia S.R.L.
E-Mail: info.es@geze.com
www.geze.es

India
GEZE India Private Ltd.
E-Mail: office-india@geze.com
www.geze.in

Italy
GEZE Italia S.r.l. Unipersonale
E-Mail: italia.it@geze.com
www.geze.it

GEZE Engineering Roma S.r.l.
E-Mail: italia.it@geze.com
www.geze.it

Korea
GEZE Korea Ltd.
E-Mail: info.kr@geze.com
www.geze.com

Poland
GEZE Polska Sp.z o.o.
E-Mail: geze.pl@geze.com
www.geze.pl

Romania
GEZE Romania S.R.L.
E-Mail: office-romania@geze.com
www.geze.ro

Russia
OOO GEZE RUS
E-Mail: office-russia@geze.com
www.geze.ru

Scandinavia – Sweden
GEZE Scandinavia AB
E-Mail: sverige.se@geze.com
www.geze.se

Scandinavia – Norway
GEZE Scandinavia AB avd. Norge
E-Mail: norge.se@geze.com
www.geze.no

Scandinavia – Denmark
GEZE Danmark
E-Mail: danmark.se@geze.com
www.geze.dk

Singapore
GEZE (Asia Pacific) Pte. Ltd.
E-Mail: gezeasia@geze.com.sg
www.geze.com

South Africa
GEZE South Africa (Pty) Ltd.
E-Mail: info@gezes.co.za
www.geze.co.za

Switzerland
GEZE Schweiz AG
E-Mail: schweiz.ch@geze.com
www.geze.ch

Turkey
GEZE Kapi ve Pencere Sistemleri
E-Mail: office-turkey@geze.com
www.geze.com

Ukraine
LLC GEZE Ukraine
E-Mail: office-ukraine@geze.com
www.geze.ua

United Arab Emirates/GCC
GEZE Middle East
E-Mail: gezeme@geze.com
www.geze.ae

United Kingdom
GEZE UK Ltd.
E-Mail: info.uk@geze.com
www.geze.com

Tel.: 0049 7152 203 0
Fax: 0049 7152 203 310
www.geze.com



3.2 Protection of the smoke detector from contamination

- ! Do not remove the dust protection cap from the smoke detector until commissioning is about to take place.
- ! After the smoke detector has been installed and the dust protection removed, make sure no dust gets into the measuring chamber. This leads to increased contamination and can significantly shorten the service life of the smoke detector.
- ! The measuring chamber of a smoke detector must not be opened.

i Heed the document for the hold-open system FA GC 150 or FA GC 160 - Instructions for the installation, commissioning, operation and maintenance, see www.geze.com.

3.3 Technical data

Wireless ceiling-mounted smoke detector GC 172 comprising:	ID 195522
	<ul style="list-style-type: none"> ▫ Base GC 170 B ▫ Wireless smoke detector GC 002 F ▫ Two batteries
Battery type	CR 123A (3 V DC)
Colour	White, RAL 9016
Dimensions (with base, Ø × H)	110 mm × 65 mm
Functional principle	Scatter light, adaption of the alarm threshold, no alarm saving (self-resetting as soon as there is no more smoke in the measuring chamber)
Insect grid	Prevents insects getting into the measuring chamber
Installation position	Ceiling mounting
IP rating (in accordance with EN 60529)	IP20, only for dry areas
Relative humidity	95% (non-condensing)
Ambient temperature	-10 °C to 55 °C
Detector test	To activate test mode: <ul style="list-style-type: none"> ▶ Move the test magnet near to the magnetic sensor (GEZE logo). The LED flashes green. Alarm triggering: <ul style="list-style-type: none"> ▶ Move the test magnet near to the magnetic sensor (GEZE logo) again. ▶ Trigger the alarm using the test aerosol. <p>The detector test using a test magnet tests the electrical components. The detector test which forms part of the regular testing of the hold-open system must be carried out using a test aerosol</p>
Battery life span	8 years
Signal transfer period	60 s
Antenna	Integrated
Frequency range	868.15 MHz to 869.85 MHz
Range	10 m (100 m in space)
Number of frequency channels	7
Modulation technique	FSK (frequency shift keying)
Radiated power	10 dBm / 10 mW

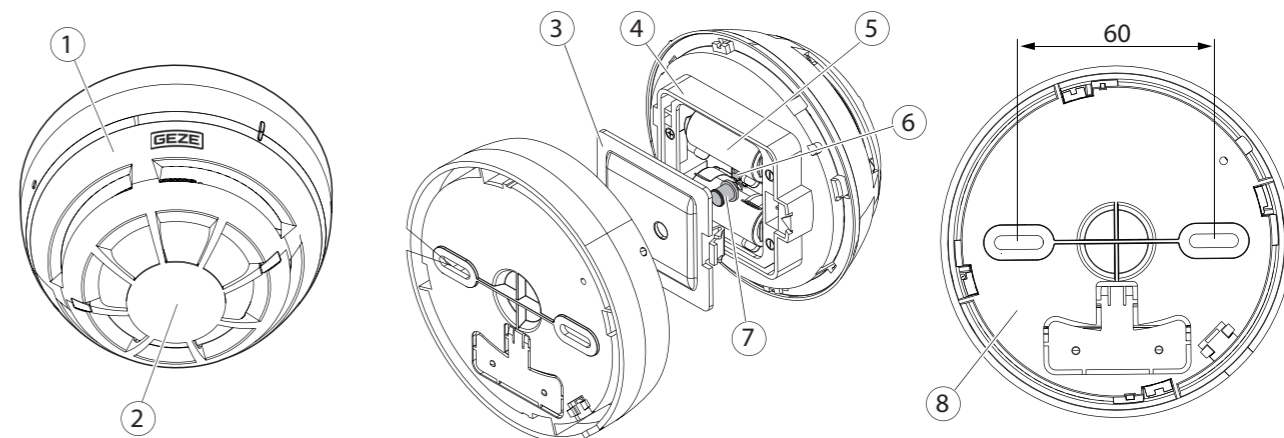

- | | | | | | |
|---|--|---|---------------------|---|------------------|
| 1 | Magnetic sensor for testing (behind the GEZE logo) | 4 | Battery compartment | 7 | Sabotage contact |
| 2 | LED for displaying state | 5 | Batteries | 8 | Base |
| 3 | Battery compartment cover | 6 | Set-up switch | | |

1 Safety instructions

- To ensure personal safety, it is important to follow these safety instructions. These instructions must be kept.
- Before installation, read and observe the safety notes for these components and the drive. Warranty claims require proper mounting, installation and maintenance in accordance with the manufacturer's specifications.
 - Only appropriately qualified people may carry out installation, commissioning and maintenance. Unauthorised modifications to the system release GEZE from liability for any resulting damages.
 - Only use GEZE original parts for repair and service work.
 - Observe the latest versions of guidelines, standards and country-specific regulations.
 - Protect the components of the GC 172 from construction dirt and water.

2 Brief description of wireless kit

- The wireless kit is part of the GEZE hold-open system FA GC 150 or FA GC 160. The wireless module GC 171, ID 163051, makes wireless communication possible between the lintel-mounted smoke switch and the various wireless devices:
- Wireless ceiling-mounted smoke detector GC 172 ID 195522
 - Wireless ceiling-mounted thermal detector GC 173 ID 195523
 - Wireless input module GC 175, ID 163068 (for the connection of manual trigger switches or contacts for the fire alarm system)

3 Wireless ceiling-mounted smoke detector GC 172

3.1 Use

The GC 172 is a wireless ceiling-mounted smoke detector for use in the GEZE hold-open system FA GC 150 or FA GC 160. Signal transfer from the detector takes place wirelessly.

i A wireless module GC 171 is essential for use of the wireless ceiling-mounted smoke detector GC 172.

Smoke detectors detect smoke. They work using the scattered light principle. A light transmitter and a light interface are arranged in the measuring chamber in such a way that no light reaches the interface in the normal case. If there are suspended particles (smoke) in the measuring chamber, these scatter part of the light onto the interface, which converts this into an electric signal. In other words, a smoke detector not only detects smoke but all other suspended particles and responds sensitively to contamination.

3.4 Signalling

State, event	LED for displaying state
Switch on	lights up green for 1 s, then repeated red
Start set-up of the wireless connection	flashes green until the wireless connection is established
Fault during set-up of the wireless connection	lights up red
Operation	off
Alarm	flashes red (0.5 s on – 0.5 s off)
Battery 1 discharged	flashes orange (0.1 s on – 5 s off)
Battery 2 discharged	flashes green (0.1 s on – 5 s off)
Both batteries discharged	flashes orange/green alternately (0.1 s on – 5 s off)
Other faults	flashes orange/green alternately (0.5 s each)
Manipulation	off
Loss of connection	off
Test mode – the detector reacts sensitively to aerosol pulses	flashes green every second for 1 minute

3.5 Battery replacement

The wireless detector signals “low battery charge” to the wireless module GC 171 if the charge state of the batteries is no longer sufficient. Both batteries (5) always have to be replaced together. The set-up switch (6) for the wireless detector must not be activated.

- ▶ Take the wireless detector out of the base (8).
- ▶ Remove the battery compartment cover (3).
- ▶ Remove both batteries (5).
- ▶ Insert new batteries (type CR123A) – make sure polarity is correct.
- ▶ Replace the battery compartment cover (3).
- ▶ Insert the wireless detector into the base (8).
- ▶ Test the wireless detector. It can take up to a minute for the wireless detector to be ready for operation after battery replacement.

3.6 Connecting the wireless ceiling-mounted smoke detector GC 172 to wireless module GC 171

A maximum of 6 wireless connections can be set up at one wireless module GC 171.

Pre-conditions

- All the wireless device switches of the wireless module GC 171 are in the OFF position.

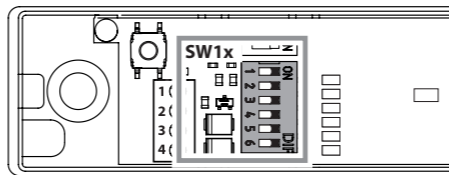

- The set-up switch (6) of the new wireless detector is set to the ON position.

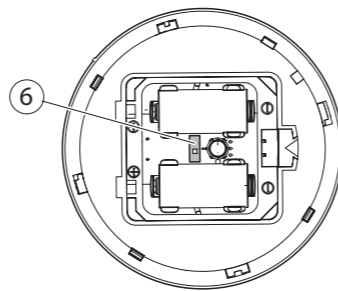

- The protective films are on the battery compartment of the new wireless detector and the batteries for the new wireless detector have not been fitted.

Set up a new wireless connection

- ▶ Switch the supply voltage for the wireless module GC 171 on. The wireless module is in “operating” mode.
- ▶ Press the PB1 push button on the wireless module GC 171 briefly to change to the “set up wireless connection” mode. The status LED2 of the wireless module GC 171 now lights up red permanently.

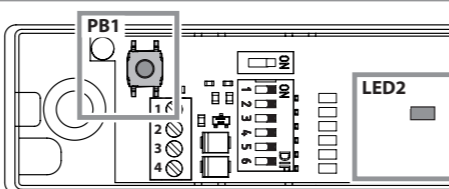

Set up wireless connection

- ▶ Slide a free wireless device switch SW1x of the wireless module GC 171 to the ON position. The corresponding wireless device LED1x starts to flash green. If a connection has already been set up for the wireless device switch selected, this is overwritten by the following process. The wireless module GC 171 waits for the connection query for a new wireless device. If a new wireless device does not respond within 2 minutes, the wireless module GC 171 cancels the connection attempt, the corresponding wireless device LED1x lights up red.
- ▶ To start the connection attempt again, slide the corresponding wireless device switch SW1x to the OFF position briefly, then slide it back into the ON position. The corresponding wireless device LED1x now flashes green again for 2 minutes.

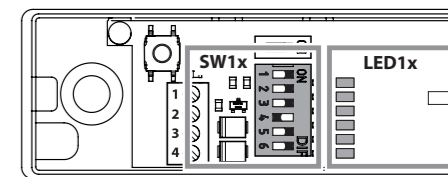

Install batteries

- ▶ Remove the protective films from the battery compartment (4) of the new wireless detector and install the batteries (5) in the new wireless detector. Make sure of correct polarity.

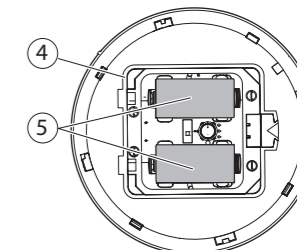

The LED (2) on the new wireless ceiling-mounted detector flashes green twice first, then lights up orange for one second and then flashes red four times. As soon as the LED (2) goes out after that, the connection can be set up.

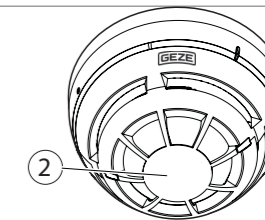

- ▶ Slide the set-up switch (6) on the new wireless detector to the 1 position. After a short time, the LED of the new wireless detector will flash green for a few seconds. The corresponding wireless device LED1x of the wireless module GC 171 lights up green permanently.

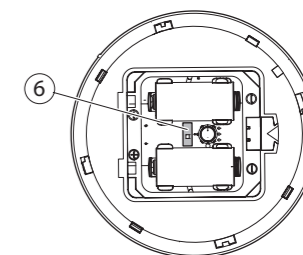

If the LED (2) on the new wireless detector lights up red permanently, no connection has been made.

- ▶ In this case, remove the batteries from the new wireless detector, slide the set-up switch (6) on the new wireless detector back and forward six times and install the batteries (5) again. Continue as described above.
- ▶ Fit the wireless ceiling-mounted smoke detector to the base (8).

- ▶ Slide the wireless device switch SW1x of the wireless module GC 171 to the OFF position again.

The colour the corresponding wireless device LED1x flashes indicates the quality of the wireless connection (see connection quality).

- ▶ Optimise the quality of the wireless connection if necessary by changing the position of the wireless detector.

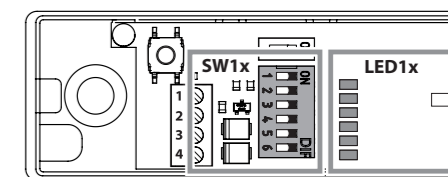

The connection of the wireless module GC 171 to the new wireless detector has been set up.

- ▶ Note the set-up connection (the number of the assigned wireless device switch) onto the identification plate of the new wireless detector.
- ▶ To set up further wireless connections, continue with step “Set up wireless connection”.

- ▶ Press the PB1 push button on the wireless module GC 171 briefly to change to the “operating” mode.

The status LED2 of the wireless module GC 171 goes off.

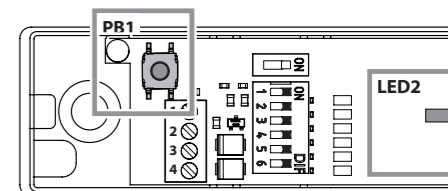

GEZE GmbH hereby declares that the components of the wireless kit for hold-open systems complies with the Directives 2014/53/EU and 2011/65/EU. The complete text of the EU Declaration of Conformity, and the Declaration of Performance, is available at the following internet address: www.geze.com

EN 54-7*
EN 54-25*
EN 14637**



* EN 54-7 and EN 54-25 certified by BRE Global Ireland only with the GC171_L gateway (see document L20-GC171_-0001_REV_A.1).
** EN 14637 certified by KRIWAN with GC 172, GC 173, GC 175 and GC171 gateway.